

NO	Model	Fan Dia. (mm)	Voltage (V)	Current (A)	Power (W)	Speed (rpm)	Air Flow (m3/h)	IP	Weight (Kg)	Sound pressure level* (dBA)
7	VIE-40T4S	400	220	1.25	230	1340	3600	54	8.3	60
8	VIE-40T4T	400	380	0.62	250	1400	3800	54	8.3	62
9	VIE-50T4S	500	220	1.8	360	1270	5700	54	9.2	71
10	VIE-50T4T	500	380	0.75	320	1300	5900	54	9.2	72
11	VIE-60Z4S	600	220	3.4	690	1300	10000	54	17.7	73
12	VIE-60Z4T	600	380	1.4	680	1380	10800	54	17.7	75
13	VIE-70Z4T	700	380	3	1450	1380	16500	54	30	83

*صدای محصول در فاصله معادل ۳ برابر قطر محصول (با حداقل فاصله 1.5 m) اندازه گیری شده است.

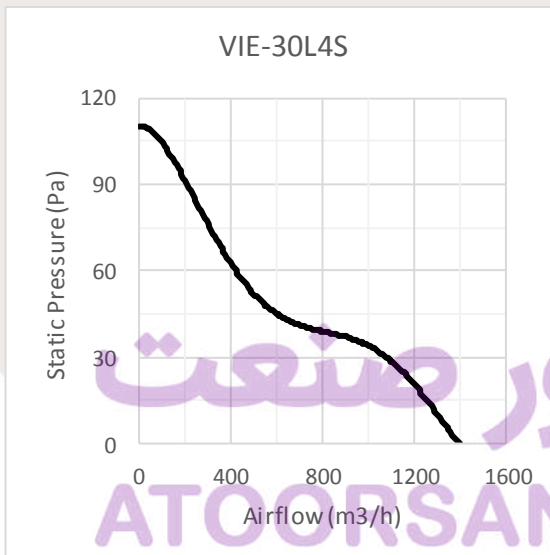

1

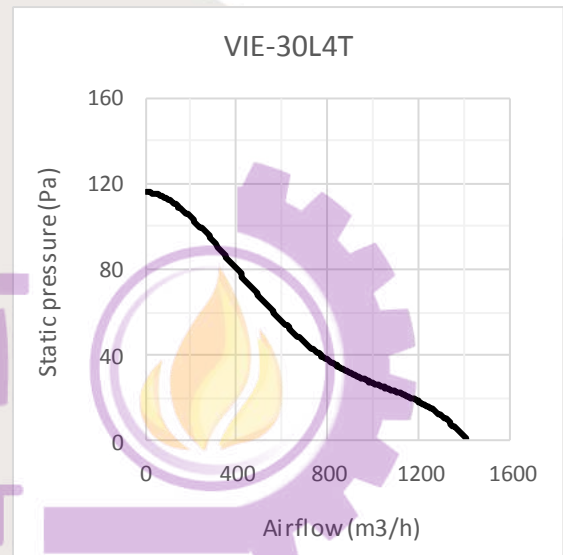

2

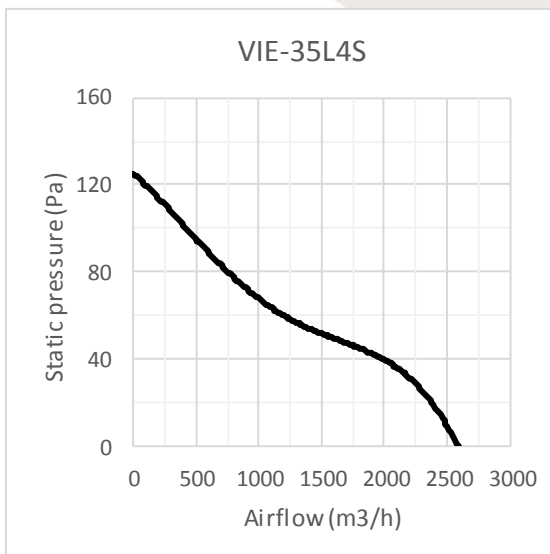

3

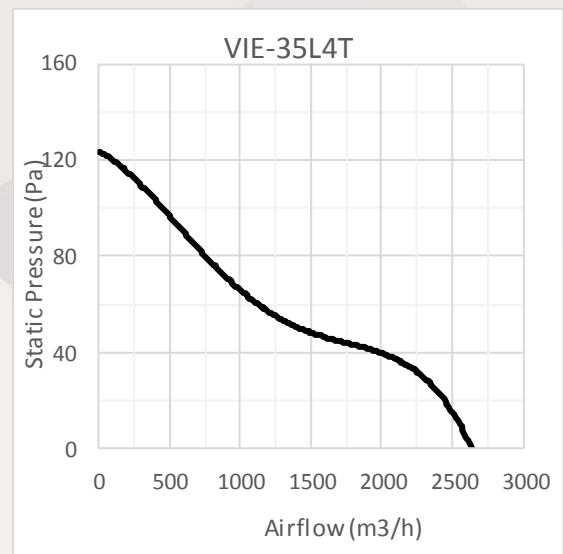

4



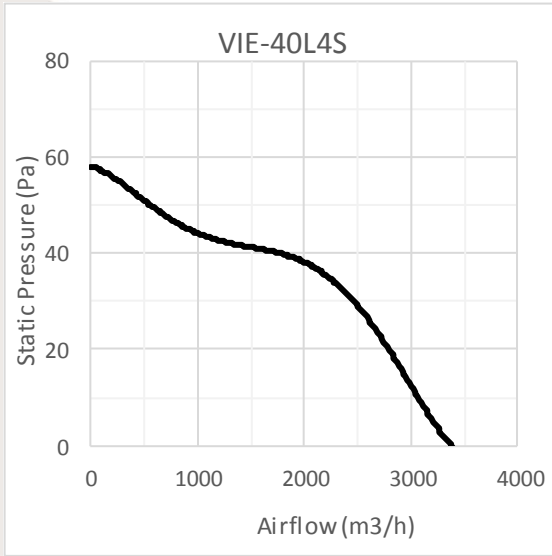

5

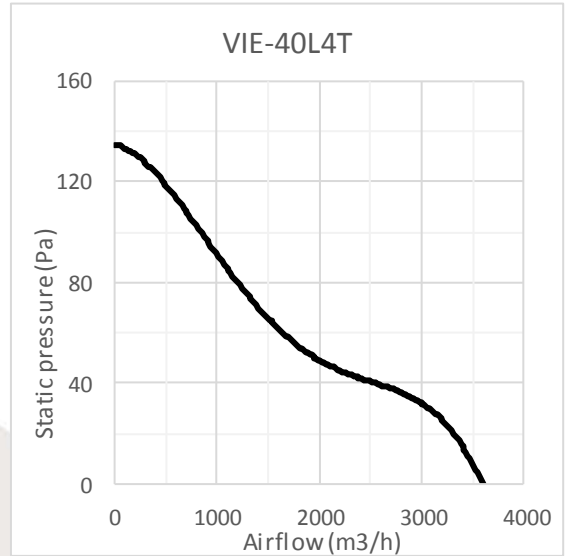

6

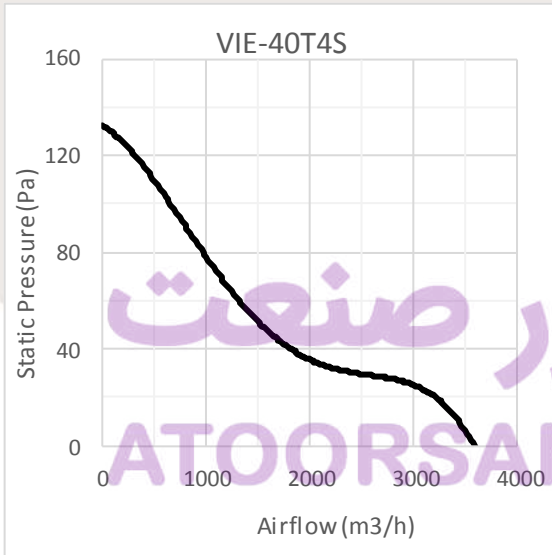

7

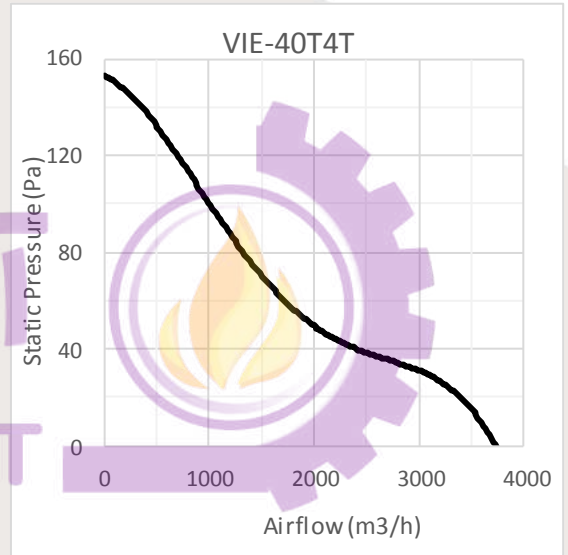

8

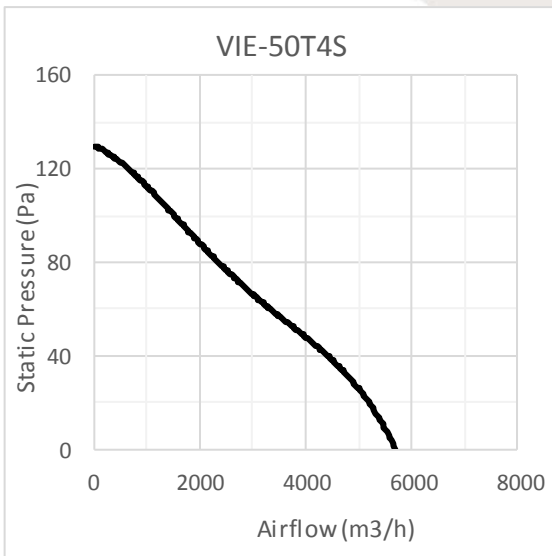

9

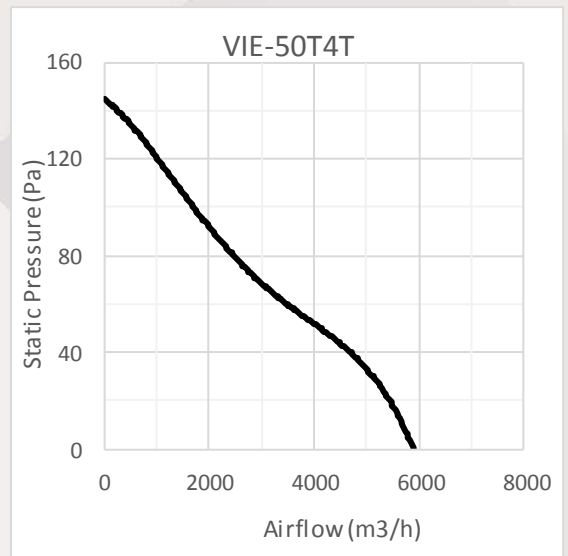

10

فہرست
Products Index

برہانہ شرکت
About the company

انتخاب فن
Fan Selection

خانگی
Residential Products

صنعتی و OEM
Industrial and OEM Fans

فن های سنترلیفل
Centrifugal Fans

سایر محصولات
Other Products

تجهیزات تهویه
Parking ventilation



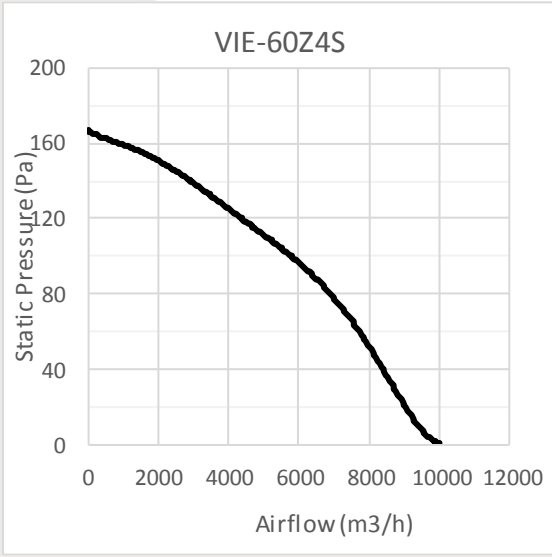

11

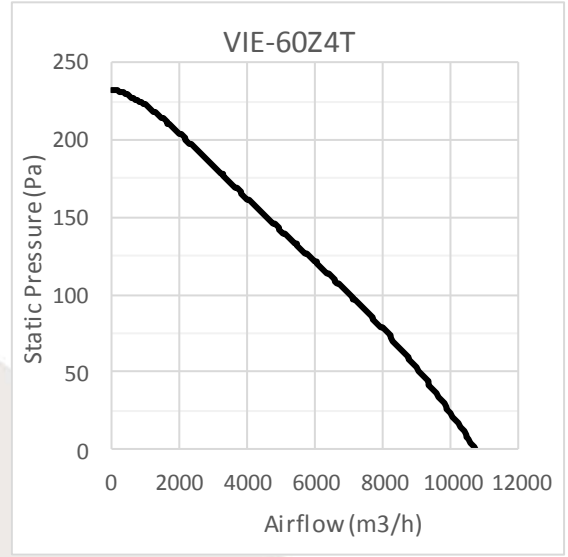

12

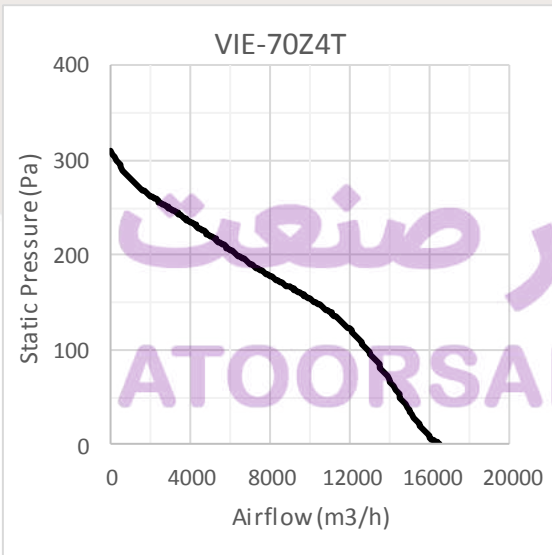

13



فہرست
Products Index

برابرہ شرکت
About the company

انتخاب فن
Fan Selection

خانگی
Residential Products

صنعتی و OEM
Industrial and OEM Fans

فنی سانچوں کی فہرست
Centrifugal Fans

سب سے زیادہ
Other Products

تعمیراتی
Parking ventilation



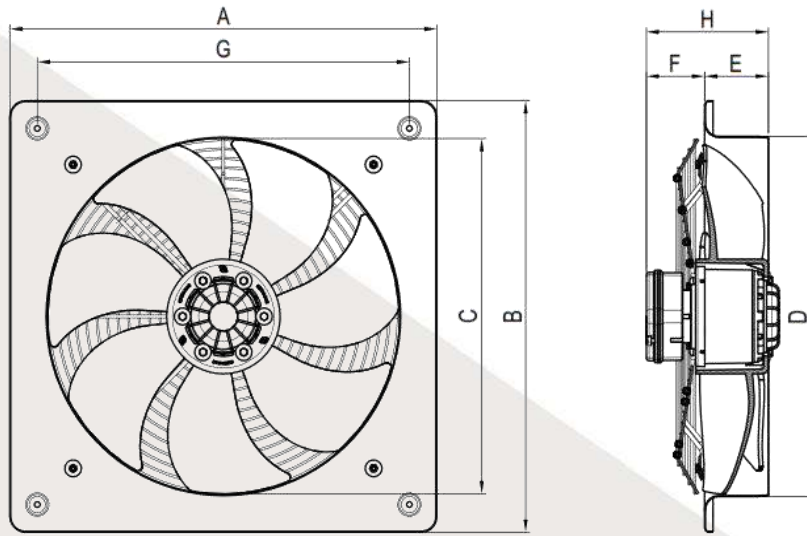

Model	A	B	C	D	E	F	G
VIE-30	400	400	280	300	60	100	330
VIE-35	450	450	330	350	70	75	370
VIE-40L	500	500	380	400	75	80	425
VIE-40T	500	500	380	400	75	110	425
VIE-50	600	600	480	500	90	80	510
VIE-60	725	725	580	600	120	100	625
VIE-70	850	850	680	700	140	100	735

جدول ابعاد بر حسب میلیمتر ارائه شده است.

ATOORSANAT

